

# AU OPTRONICS CORPORATION

## Product Specifications

### 20.1" UXGA Color TFT-LCD Module

**Model Name: M201UN02  
V.3**

| Approved by   | Prepared by         |
|---------------|---------------------|
| <i>CCChiu</i> | <i>Archer Cheng</i> |

*DDBU Marketing Division / AU Optronics Corporation*

| Customer | Checked & Approved by |
|----------|-----------------------|
|          |                       |

## **Product Specifications**

**20.1" UXGA Color TFT-LCD Module**  
**Model Name: M201UN02**  
**V.3**

**( ) Preliminary Specifications**  
**( ◆ ) Final Specifications**

**Note: This Specification is subject to change without notice.**

## **i Contents**

### **ii Record of Revision**

#### **1.0 Handling Precautions**

#### **2.0 General Description**

- 2.1 Display Characteristics
- 2.2 Functional Block Diagram
- 2.3 Optical Characteristics
- 2.4 Pixel format image

#### **3.0 Electrical characteristics**

- 3.1 Absolute Maximum Ratings
- 3.2 Connectors
- 3.3 Signal Pin
- 3.4 Signal Description
- 3.5 Signal Electrical Characteristics
- 3.6 Interface Timing
  - 3.6.1 Timing Characteristics
  - 3.6.2 Timing Definition
- 3.7 Power Consumption
- 3.8 Power ON/OFF Sequence

#### **4.0 Backlight Characteristics**

- 4.1 Signal for Lamp connector
- 4.2 Parameter guide line for CCFL Inverter

#### **5.0 Vibration, shock and drop**

- 5.1 Vibration and shock
- 5.2 Drop test

#### **6.0 Environment**

- 6.1 Temperature and humidity
  - 6.1.1 Operating conditions
  - 6.1.2 Shipping conditions
- 6.2 Atmospheric pressure
- 6.3 Thermal shock

#### **7.0 Reliability**

- 7.1 Failure criteria
- 7.2 Failure rate
  - 7.2.1 Usage
  - 7.2.2 Components de-rating
- 7.3 CCFL life
- 7.4 ON/OFF cycle

#### **8.0 Safety**

- 8.1 Sharp edge requirement
- 8.2 Material
  - 8.2.1 Toxicity
  - 8.2.2 Flammability
- 8.3 Capacitors
- 8.4 Hazardous voltage

#### **9.0 Other requirements**

- 9.1 Smoke free design
- 9.2 National test lab requirement

#### **10.0 Mechanical Characteristics**

(C) Copyright AU Optronics, Inc.

Dec, 2003 All Rights Reserved.

No Reproduction and Redistribution Allowed.

M201UN02 v.3 Ver1.0

3/26

## ii Record of Revision

| Version and Date | Page  | Old description                   | New Description                   | Remark   |
|------------------|-------|-----------------------------------|-----------------------------------|----------|
| 0.1 2003/12/01   | All   | First Edition for Customer        | All                               |          |
| 1.0 2004/03/25   | P.20  | CCFL operation range:<br>min. 4mA | CCFL operation range:<br>min. 3mA | Modified |
|                  | P.23  | CCFL Life : Min.30000hrs          | CCFL Life : Min.50000hrs          | Modified |
|                  | All   | Final Edition for all<br>customer |                                   |          |
| 1.1 2004/4/2     | 25/26 |                                   | Mechanical drawing note update    | Modified |

## 1.0 Handling Precautions

- 1) Since front polarizer is easily damaged, pay attention not to scratch it.
- 2) Be sure to turn off power supply when inserting or disconnecting from input connector.
- 3) Wipe off water drop immediately. Long contact with water may cause discoloration or spots.
- 4) When the panel surface is soiled, wipe it with absorbent cotton or other soft cloth.
- 5) Since the panel is made of glass, it may break or crack if dropped or bumped on hard surface.
- 6) Since CMOS LSI is used in this module, take care of static electricity and insure human earth when handling.
- 7) Do not open nor modify the Module Assembly.
- 8) Do not press the reflector sheet at the back of the module to any directions.
- 9) At the insertion or removal of the Signal Interface Connector, be sure not to rotate nor tilt the Interface Connector of the TFT-LCD module.
- 10) After installation of the TFT-LCD module into an enclosure (LCD monitor housing, for example), do not twist nor bend the TFT -LCD module even momentary. At designing the enclosure, it should be taken into consideration that no bending/twisting forces are applied to the TFT -LCD module from outside. Otherwise the TFT -LCD module may be damaged.

## 2.0 General Description

This specification applies to the 20.1 inch Color TFT-LCD Module M201UN02 v.3.

The display supports the UXGA (1600(H) x 1200(V)) screen format and 16.7M colors (RGB 8-bits data).

All input signals are 2 Channel LVDS interface compatible.

This module does not contain an inverter card for backlight.

## 2.1 Display Characteristics

The following items are characteristics summary on the table under 25 °C condition:

| ITEMS                                       | Unit                 | SPECIFICATIONS                               |
|---|----------------------|--|
| Screen Diagonal                             | [mm]                 | 510(20.1")                                   |
| Active Area                                 | [mm]                 | 408.0 (H) x 306.0 (V)                        |
| Pixels H x V                                |                      | 1600(x3) x 1200                              |
| Pixel Pitch                                 | [mm]                 | 0.255 (per one triad) x 0.255                |
| Pixel Arrangement                           |                      | R.G.B. Vertical Stripe                       |
| Display Mode                                |                      | Normally Black                               |
| White Luminance                             | [cd/m <sup>2</sup> ] | 250 cd/m <sup>2</sup> (Typ)                  |
| Contrast Ratio                              |                      | 700 : 1 (Typ)                                |
| Optical Response Time<br>( Gray to Gray)    | [msec]               | 16 (Typ)                                     |
| Nominal Input Voltage VDD                   | [Volt]               | +5.0 V                                       |
| Power Consumption<br>(VDD line + CCFL line) | [Watt]               | 45W(typ.) (w/o Inverter, All white pattern)  |
| Weight                                      | [Grams]              | 3000 (Typ)                                   |
| Physical Size                               | [mm]                 | 432(W) x 331.4(H) x 23.1(D)                  |
| Electrical Interface                        |                      | Even/Odd R/G/B data, 3 sync signal,<br>Clock |
| Support Color                               |                      | 16.7M colors (RGB 8-bit data )               |
| Temperature Range                           |                      |  |
| Operating                                   | [°C]                 | 0 to +50                                     |
| Storage (Shipping)                          | [°C]                 | -20 to +60                                   |

## 2.2 Functional Block Diagram

The following diagram shows the functional block of the 20.1 inches Color TFT-LCD Module:

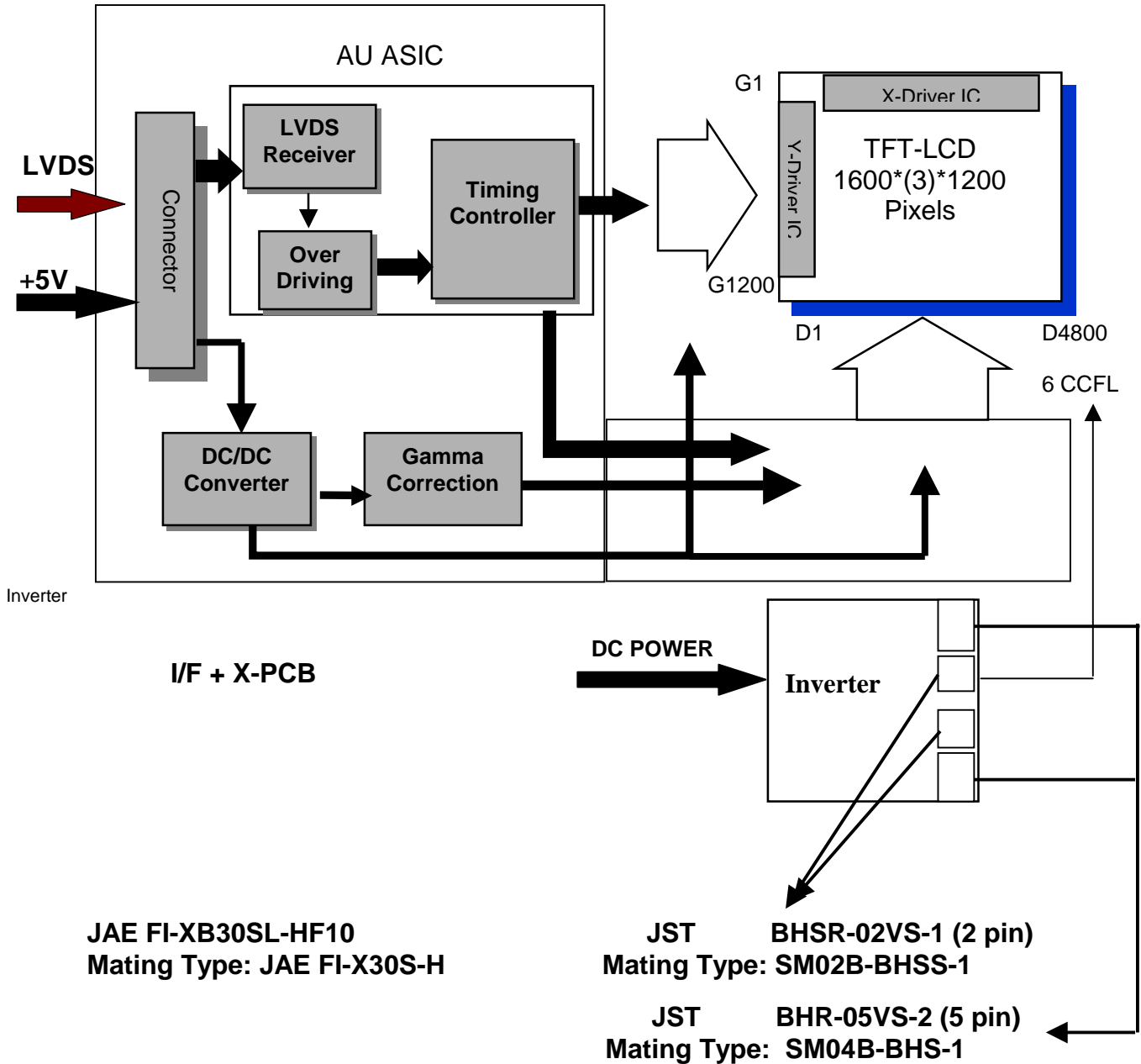

### 2.3 Optical Characteristics

The optical characteristics are measured under stable conditions at 25°C (Room Temperature):

| Item  | Unit                 | Conditions         | Min.  | Typ.  | Max.  |
|---|----------------------|--------------------|-------|-------|-------|
| Viewing Angle                                 | [degree]             | Horizontal (Right) | 75    | 85    | -     |
|   | [degree]             | CR = 10 (Left)     |       | 85    | -     |
|   | [degree]             | Vertical (Up)      | 75    | 85    | -     |
|   | [degree]             | CR = 10 (Down)     |       | 85    | -     |
| Contrast ratio                                |                      | Normal Direction   | 400   | 700   |       |
| Response Time (Note 1 & 4)                    | [msec]               | Raising Time       | -     | 15    | 25    |
|   | [msec]               | Falling Time       | -     | 10    | 15    |
|   | [msec]               | Raising + Falling  | -     | 25    | 40    |
|   | [msec]               | Gray to Gray       | -     | 16    |       |
| Color / Chromaticity Coordinates (CIE)        |                      | Red x              | 0.618 | 0.648 | 0.678 |
|   |                      | Red y              | 0.309 | 0.339 | 0.369 |
|   |                      | Green x            | 0.259 | 0.289 | 0.319 |
|   |                      | Green y            | 0.568 | 0.598 | 0.628 |
|   |                      | Blue x             | 0.113 | 0.143 | 0.173 |
|   |                      | Blue y             | 0.048 | 0.078 | 0.108 |
| Color Coordinates (CIE) White                 |                      | White x            | 0.283 | 0.313 | 0.343 |
|   |                      | White y            | 0.299 | 0.329 | 0.359 |
| White Luminance at CCFL 6.0mA (central point) | [cd/m <sup>2</sup> ] |                    | 200   | 250   | -     |
| Luminance Uniformity (Note 2)                 | [%]                  |                    | 75    | 80    | -     |
| Crosstalk (in 60Hz) (Note 3)                  | [%]                  |                    |       |       | 1.5   |

Equipment      Pattern Generator, Power Supply, Digital Voltmeter, Luminance meter (PR 880, BM-5A , BM- 7 , & EZContrast\* )  
 Aperture        1° with 100cm VD or 2° with 50cm viewing distance  
 Test Point      Center (ISO point 22)  
 Environment    < 1 lux

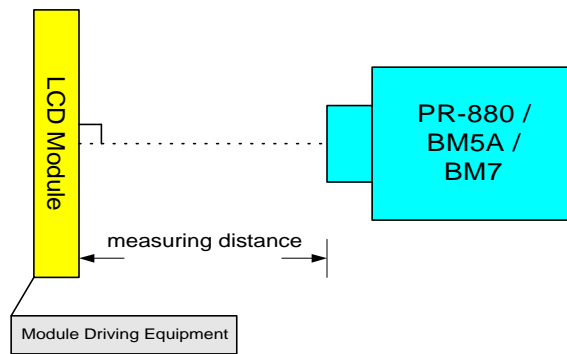

“\*” EZ Contrast is different measurement tool with very close viewing distance.

Note 1: Definition of Response time:

The output signals of photodetector are measured when the input signals are changed from “Black” to “White” (rising time), and from “White” to “Black” (falling time), respectively. The response time is interval between the 10% and 90% of amplitudes. Refer to figure as below.

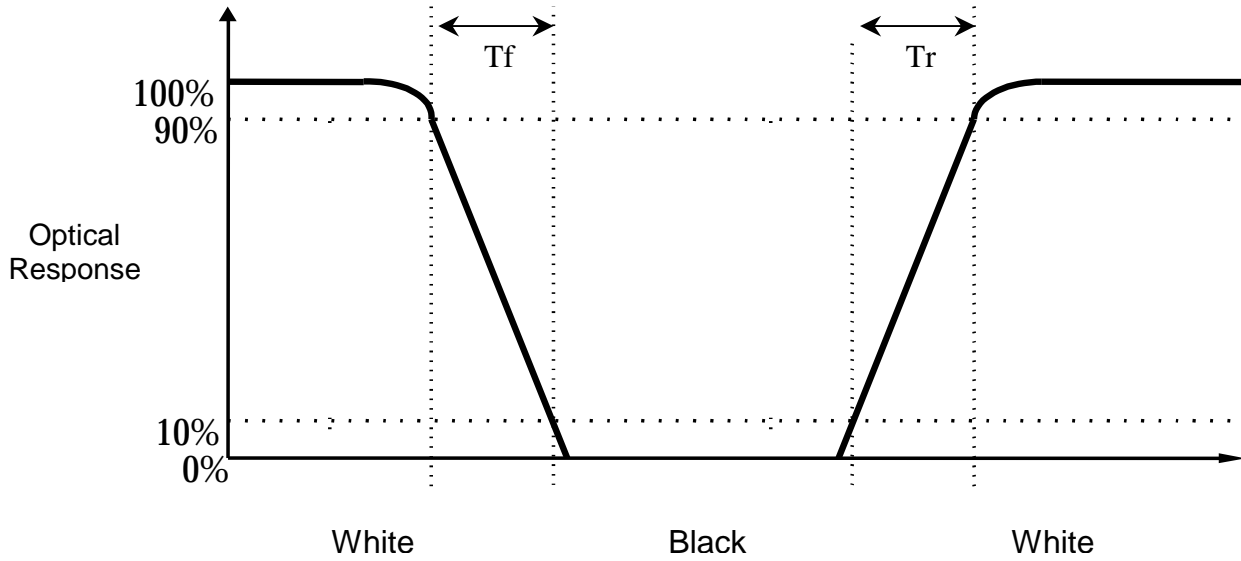

Note 2: Brightness uniformity of these 9 points is defined as below:

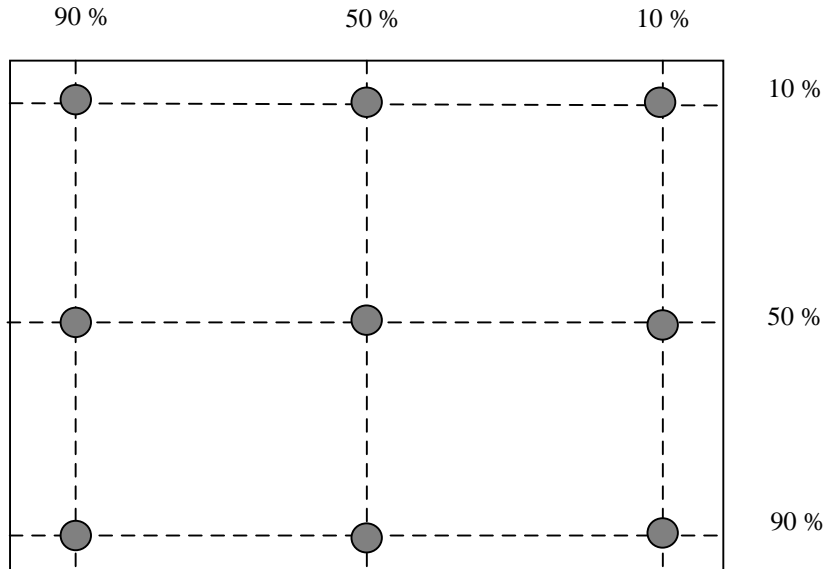

$$\text{Uniformity} = \frac{\text{Minimum Luminance in 9 Points (1-9)}}{\text{Maximum Luminance in 9 Points (1-9)}}$$



Note 3: Crosstalk is defined as below :

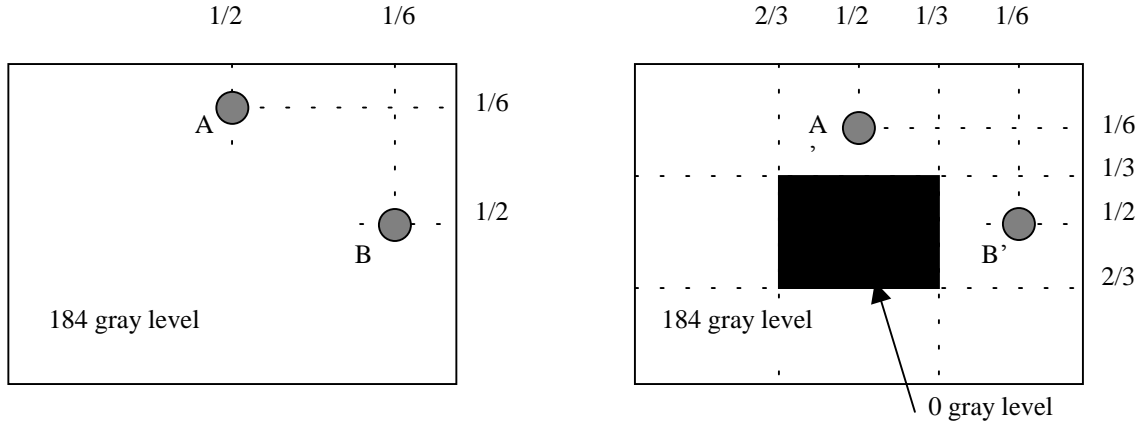

Unit: percentage of dimension of display area

$$|L_A - L_{A'}| / L_A \times 100\% = 1.5\% \text{ max.}, L_A \text{ and } L_B \text{ are brightness at location A and B}$$

$$|L_B - L_{B'}| / L_B \times 100\% = 1.5\% \text{ max.}, L_{A'} \text{ and } L_{B'} \text{ are brightness at location A' and B'}$$

Note 4: Over-Drive and Response time:

Algorithm:

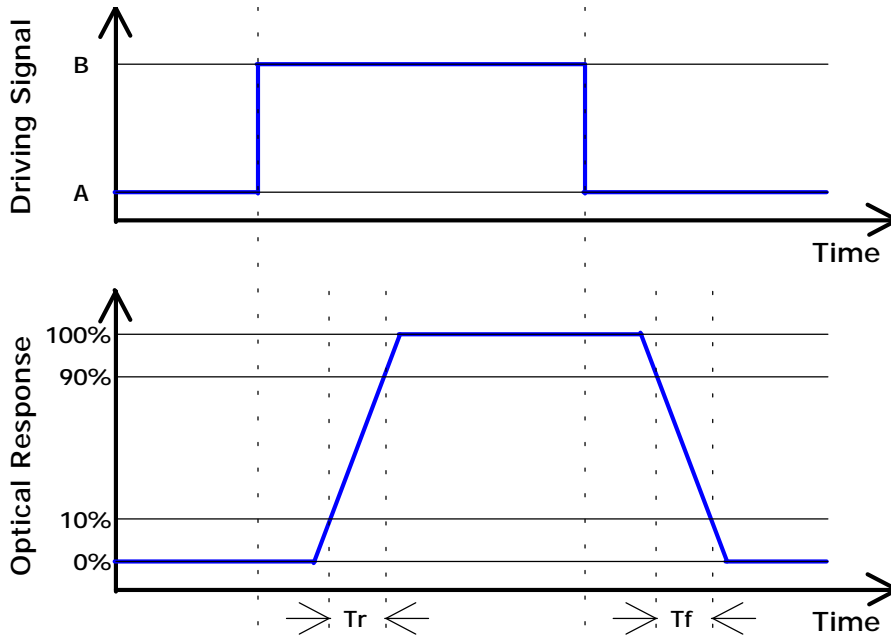

$$| \text{Level A} - \text{Level B} | \geq 16 \text{ then } T_r \leq 16\text{ms} \ \& \ T_f \leq 16\text{ms}$$

## 2.4 Pixel format image

Following figure shows the relationship of the input signals and LCD pixel format.

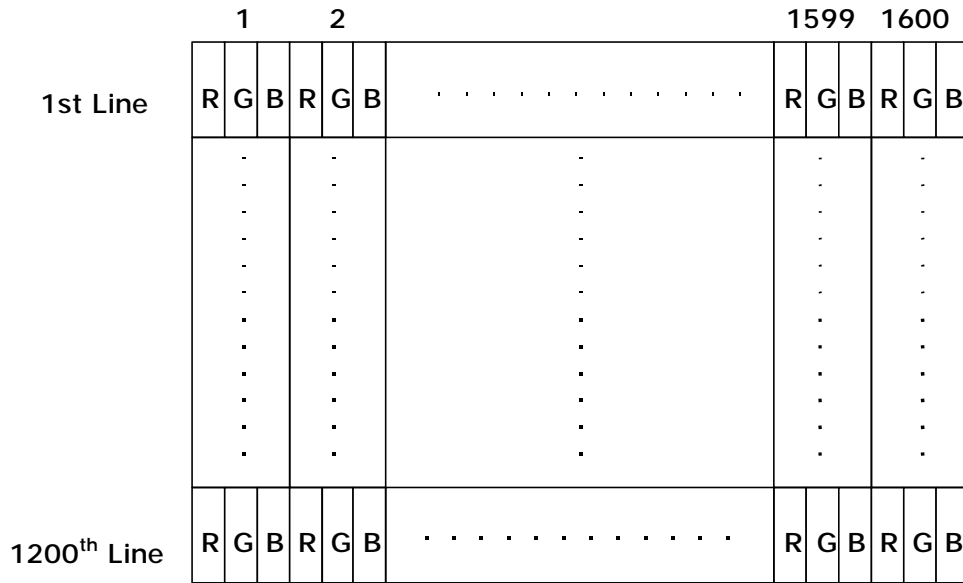

### 3.0 Electrical characteristics

#### 3.1 Absolute Maximum Ratings

Absolute maximum ratings of the module is as following:

| Item                    | Symbol  | Min  | Max  | Unit     | Conditions |
|-------------------------|---------|------|------|----------|------------|
| Logic/LCD Drive Voltage | VIN     | -0.3 | +5.5 | [Volt]   |            |
| Select LVDS data order  | SELLVDS | NC   | NC   | [Volt]   |            |
| CCFL Inrush current     | ICFLL   | -    | 40   | [mA]     | Note 1     |
| CCFL Current            | ICFL    | -    | 7.5  | [mA] rms |            |
| Operating Temperature   | TOP     | 0    | +50  | [°C]     | Note 2     |
| Operating Humidity      | HOP     | 8    | 95   | [%RH]    | Note 2     |
| Storage Temperature     | TST     | -20  | +60  | [°C]     | Note 2     |
| Storage Humidity        | HST     | 8    | 95   | [%RH]    | Note 2     |

**Note 1 : Duration=50 msec.**

**Note 2 : Maximum Wet-Bulb should be 39°C and No condensation.**

#### Relative Humidity %

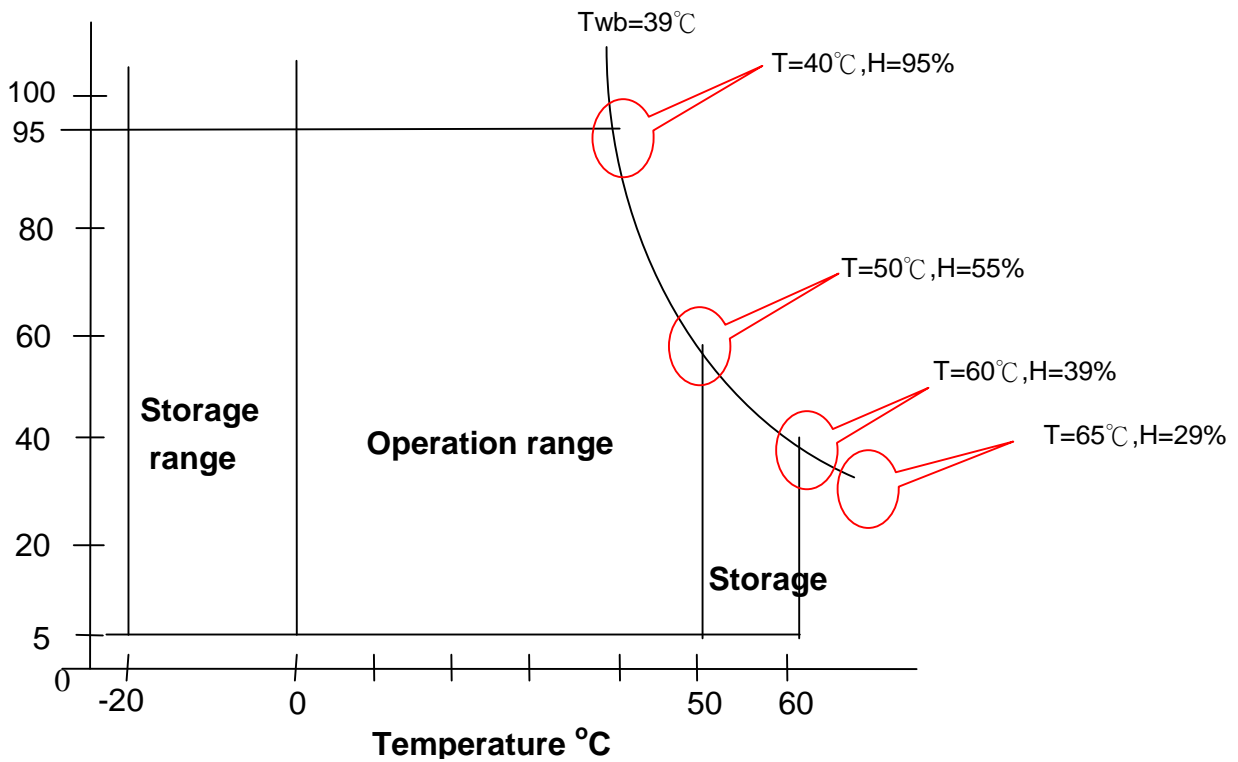

### 3.2 Connectors

Physical interface is described as for the connector on module.

These connectors are capable of accommodating the following signals and will be following components.

|                                     |                                      |
|-------------------------------------|--------------------------------------|
| <b>Connector Name / Designation</b> | Interface Connector / Interface card |
| <b>Manufacturer</b>                 | JAE or compatible                    |
| <b>Type Part Number</b>             | FI-XB30SL-HF10                       |
| <b>Mating Housing Part Number</b>   | FI-X30S-H                            |

|                                     |  |
|-------------------------------------|--|
| <b>Connector Name / Designation</b> | Lamp Connector / Backlight lamp          |
| <b>Manufacturer</b>                 | JST                                      |
| <b>Type Part Number</b>             | BHSR-02VS-1 (2 pin), BHR-05VS-2 (5 pin)  |
| <b>Mating Type Part Number</b>      | SM02B-BHSS-1(2 pin), SM04B-BHS-1 (5 pin) |

### 3.3 Signal Pin

| Pin# | Signal Name | Pin# | Signal Name |
|------|-------------|------|-------------|
| 1    | RxO0-       | 2    | RxO0+       |
| 3    | RxO1-       | 4    | RxO1+       |
| 5    | RxO2-       | 6    | RxO2+       |
| 7    | GND         | 8    | RxOC-       |
| 9    | RxOC+       | 10   | RxO3-       |
| 11   | RxO3+       | 12   | RxE0-       |
| 13   | RxE0+       | 14   | GND         |
| 15   | RxE1-       | 16   | RxE1+       |
| 17   | GND         | 18   | RxE2-       |
| 19   | RxE2+       | 20   | RxEC-       |
| 21   | RxEC+       | 22   | RxE3-       |
| 23   | RxE3+       | 24   | GND         |
| 25   | NC          | 26   | NC          |
| 27   | NC          | 28   | Power       |
| 29   | Power       | 30   | Power       |

### 3.4 Signal Description

The module using a pair of LVDS receiver SN75LVDS82(Texas Instruments) or compatible. LVDS is a differential signal technology for LCD interface and high speed data transfer device. Transmitter shall be SN75LVDS83(negative edge sampling) or compatible. The first LVDS port(RxOxxx) transmits odd pixels while the second LVDS port(RxExxx) transmits even pixels.

| PIN # | SIGNAL NAME | DESCRIPTION  |
|-------|-------------|--|
| 1     | RxO0-       | Negative LVDS differential data input (Odd data)                       |
| 2     | RxO0+       | Positive LVDS differential data input (Odd data)                       |
| 3     | RxO1-       | Negative LVDS differential data input (Odd data)                       |
| 4     | RxO1+       | Positive LVDS differential data input (Odd data)                       |
| 5     | RxO2-       | Negative LVDS differential data input (Odd data, H-Sync,V-Sync,DSPTMG) |
| 6     | RxO2+       | Positive LVDS differential data input (Odd data, H-Sync,V-Sync,DSPTMG) |
| 7     | GND         | Power Ground   |
| 8     | RxOC-       | Negative LVDS differential clock input (Odd clock)                     |
| 9     | RxOC+       | Positive LVDS differential clock input (Odd clock)                     |
| 10    | RxO3-       | Negative LVDS differential data input (Odd data)                       |
| 11    | RxO3+       | Positive LVDS differential data input (Odd data)                       |
| 12    | RxE0-       | Negative LVDS differential data input (Even clock)                     |
| 13    | RxE0+       | Positive LVDS differential data input (Even data)                      |
| 14    | GND         | Power Ground   |
| 15    | RxE1-       | Positive LVDS differential data input (Even data)                      |
| 16    | RxE1+       | Negative LVDS differential data input (Even data)                      |
| 17    | GND         | Power Ground   |
| 18    | RxE2-       | Negative LVDS differential data input (Even data)                      |
| 19    | RxE2+       | Positive LVDS differential data input (Even data)                      |
| 20    | RxEC-       | Negative LVDS differential clock input (Even clock)                    |
| 21    | RxEC+       | Positive LVDS differential clock input (Even clock)                    |
| 22    | RxE3-       | Negative LVDS differential data input (Even data)                      |
| 23    | RxE3+       | Positive LVDS differential data input (Even data)                      |
| 24    | GND         | Power Ground   |
| 25    | NC          | -  |
| 26    | NC          | -  |
| 27    | NC          | -  |
| 28    | POWER       | Power  |
| 29    | POWER       | Power  |
| 30    | POWER       | Power  |

**Note:** Input signals of odd and even clock shall be the same timing.

| LVDS DATA Name | Description  |
|----------------|--|
| DSP            | Display Timing: When the signal is high, the pixel data shall be valid to be displayed |
| V-S            | Vertical Sync: Both Positive and Negative polarity are acceptable                      |
| H-S            | Horizontal Sync: Both Positive and Negative polarity are acceptable                    |

| TI LVDS X'mitter<br>SN75LVDS83 | Module LVDS signal<br>(interface connector pin7) |
|--------------------------------|--|
| Signal Name                    | Low(open)  |
| D0                             | Red0   |
| D1                             | Red1   |
| D2                             | Red2   |
| D3                             | Red3   |
| D4                             | Red4   |
| D5                             | Red7   |
| D6                             | Red5   |
| D7                             | Green0   |
| D8                             | Green1   |
| D9                             | Green2   |
| D10                            | Green6   |
| D11                            | Green7   |
| D12                            | Green3   |
| D13                            | Green4   |
| D14                            | Green5   |
| D15                            | Blue0  |
| D16                            | Blue6  |
| D17                            | Blue7  |
| D18                            | Blue1  |
| D19                            | Blue2  |
| D20                            | Blue3  |
| D21                            | Blue4  |
| D22                            | Blue5  |
| D23                            | NA   |
| D24                            | H Sync   |
| D25                            | V Sync   |
| D26                            | Display Timing                                   |
| D27                            | Red6   |

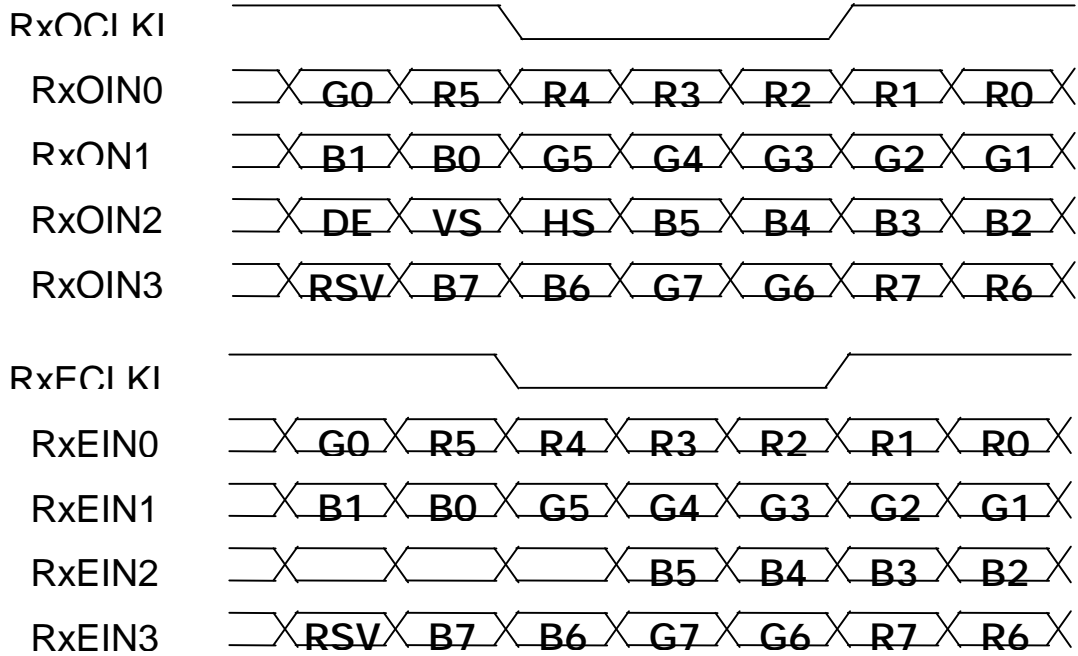

**Note: R/G/B data 7:MSB, R/G/B data 0:LSB**

O = "First Pixel Data"  
E = "Second Pixel Data"

### 3.5 Signal Electrical Characteristics

Input signals shall be low or Hi-Z state when Vin is off

It is recommended to refer the specifications of SN75LVDS82DGG (Texas Instruments) in detail.

Each signal characteristics are as follows;

| Parameter | Condition                                  | Min  | Max | Unit |
|-----------|--|------|-----|------|
| Vth       | Differential Input High Voltage(Vcm=+1.2V) |      | 100 | [mV] |
| Vtl       | Differential Input Low Voltage(Vcm=+1.2V)  | -100 |     | [mV] |

Note: The value of Vcm from LVDS transmitter should follow the following guide.

| Parameter | Min  | Typ. | Max   | Unit |
|-----------|------|------|-------|------|
| Vcm       | +1.0 | +1.2 | +1.35 | [V]  |

### 3.6 Interface Timings

Basically, interface timings described here is not actual input timing of LCD module but output timing of SN75LVDS82DGG (Texas Instruments) or equivalent.

#### 3.6.1 Timing Characteristics (DE mode only)

| Signal             | Item      | Symbol                 | Min  | Typ  | Max  | Unit |
|--------------------|-----------|------------------------|------|------|------|------|
| Vertical Section   | Period    | Tv                     | 1211 | -    | 2048 | Th   |
|                    | Active    | Tdisp(v)               | 1200 | 1200 | 1200 | Th   |
|                    | Blanking  | Tbp(v) + Tfp(v) + PWvs | 11   | -    | 848  | Th   |
| Horizontal Section | Period    | Th                     | 860  | -    | 1500 | Tclk |
|                    | Active    | Tdisp(h)               | 800  | 800  | 800  | Tclk |
|                    | Blanking  | Tbp(h) + Tfp(h) + PWhs | 60   | -    | 700  | Tclk |
| Clock              | Period    | Tclk                   | 12   | -    | -    | ns   |
|                    | Frequency | Freq                   | -    | -    | 83   | MHz  |



### 3.6.2 Timing Definition

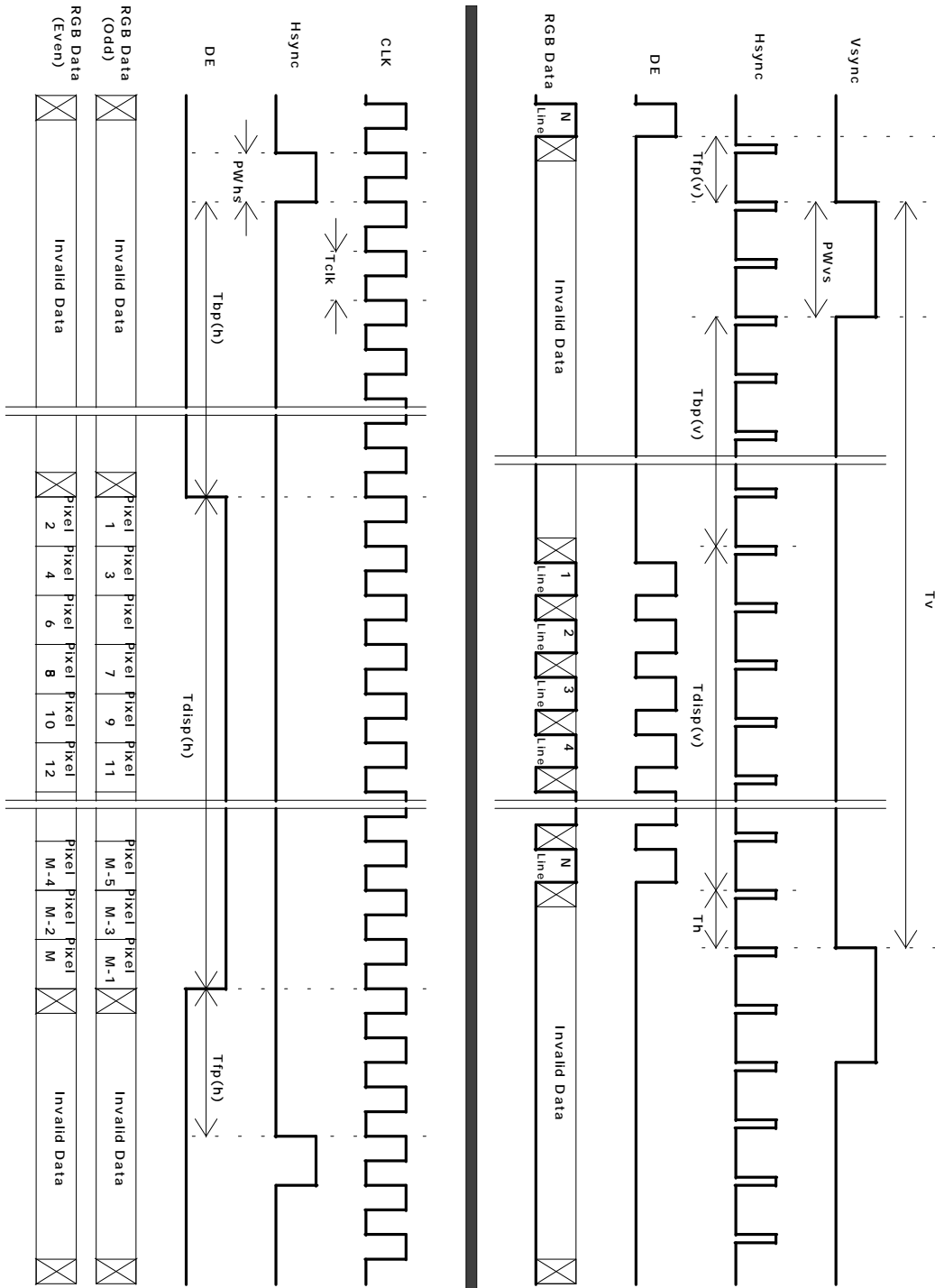

Note :1600X1200 at 60 Hz (VESA STANDARD)

### 3.7 Power Consumption

Input power specifications are as follows;

| Symbol | Parameter                                | Min | Typ  | Max | Units       | Condition                 |
|--------|--|-----|------|-----|-------------|---------------------------|
| VDD    | Logic/LCD Drive Voltage                  | 4.5 | 5    | 5.5 | [Volt]      |                           |
| IDD    | VDD current                              |     | 1300 |     | [mA]        |                           |
| IIDD   | Inrush VDD current                       |     |      | 7   | [A]         | t < 80us                  |
| PDD    | VDD Power                                |     | 6.5  | 8   | [Watt]      | Vin=5V, All White Pattern |
| VDDrp  | Allowable Logic/LCD Drive Ripple Voltage |     |      | 100 | [mV]<br>p-p |                           |
| VDDns  | Allowable Logic/LCD Drive Ripple Noise   |     |      | 100 | [mV]<br>p-p |                           |

### 3.8 Power ON/OFF Sequence

Vin power and lamp on/off sequence is as follows. Interface signals are also shown in the chart. Signals from any system shall be Hi-Z state or low level when Vin is off.

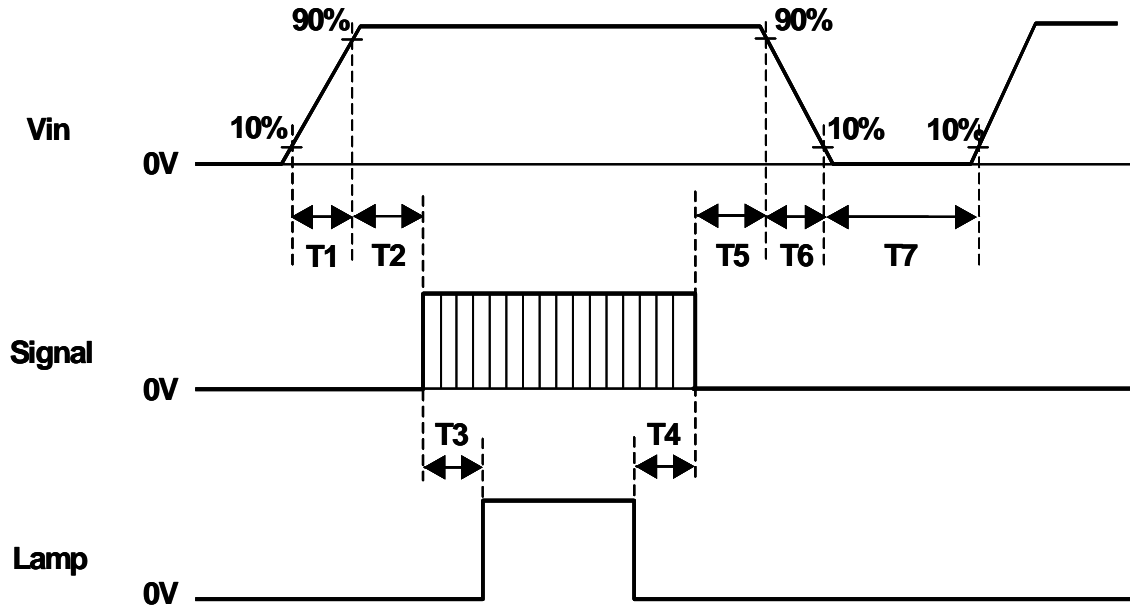

| Symbol | Values |     |     | Unit |
|--------|--------|-----|-----|------|
|        | Min    | Typ | Max |      |
| T1     | 0.5    | -   | 10  | [ms] |
| T2     | 0.5    | 40  | 50  | [ms] |
| T3     | 200    | -   | -   | [ms] |
| T4     | 200    | -   | -   | [ms] |
| T5     | 0.5    | 16  | 50  | [ms] |
| T6     | 0.5    | -   | 10  | [ms] |
| T7     | 1000   | -   | -   | [ms] |

## 4.0 Backlight Characteristics

### 4.1 Signal for Lamp connector

| Pin # | Signal Name       |
|-------|-------------------|
| 1     | Lamp High Voltage |
| 2     | Lamp High Voltage |
| 3     | Ground (Black)    |
| 4     | Ground (White)    |

| Pin # | Signal Name       |
|-------|-------------------|
| 1     | Lamp High Voltage |
| 2     | Ground (White)    |

### 4.2 Parameter guide line for CFL Inverter

| Symbol          | Parameter                                     | Min  | Typ | Max  | Units         | Condition           |
|-----------------|---|------|-----|------|---------------|---------------------|
| ISCFL           | CCFL standard current                         | 5.5  | 6.0 | 6.5  | [mA]<br>rms   | (Ta=25°C)           |
| IRCFL           | CCFL operation range                          | 3.0  | 6.0 | 7.5  | [mA]<br>rms   | (Ta=25°C)           |
| fCFL            | CCFL Frequency                                | 35   | 50  | 80   | [KHz]         | (Ta=25°C)<br>Note 1 |
| ViCFL<br>(0°C)  | CCFL Ignition Voltage<br>Note 4               | 1700 |     |      | [Volt]<br>rms | (Ta=0°C)<br>Note 2  |
| ViCFL<br>(25°C) | CCFL Ignition Voltage<br>Note 4               | 1200 |     |      | [Volt]<br>rms | (Ta=25°C)<br>Note 2 |
| VCFL            | CCFL Discharge Voltage<br>(Reference)<br>@6mA |      | 760 | 825  | [Volt]<br>rms | (Ta=25°C)<br>Note 3 |
| PCFL            | CCFL Power consumption<br>@6mA                |      | 27  | 29.7 | [Watt]        | (Ta=25°C)<br>Note 3 |

Note 1: CCFL Frequency should be carefully determined to avoid interference between inverter and TFT LCD

Note 2: CCFL inverter should be able to give out a power that has a generating capacity of over 1700 voltage. Lamp units need 1700 voltage minimum for ignition

Note 3: Calculator value for reference (ICFL×VCFLx6=PCFL)

Note 4: (measure for both end of lamp wire)

## 5.0 Vibration, Shock, and Drop

### 5.1 Vibration & Shock

Frequency: 10 - 200Hz  
 Sweep: 30 Minutes each Axis (X, Y, Z)  
 Acceleration: 1.5G(10~200Hz P- P)  
 Test method:

|                         |           |
|-------------------------|-----------|
| <b>Acceleration (G)</b> | 1.5       |
| <b>Frequency (Hz)</b>   | 10~200~10 |
| <b>Active time(min)</b> | 30        |

### 5.2 Shock Test Spec:

|                            |          |
|----------------------------|----------|
| <b>Acceleration (G) –a</b> | 50       |
| <b>Active time -b</b>      | 20       |
| <b>Wave form</b>           | half-sin |
| <b>Times</b>               | 1        |

Direction:  $\pm X$  ,  $\pm Y$ ,  $\pm Z$

### 5.3 Drop test

Package test: The drop height is 60 cm.

## 6.0 Environment

The display module will meet the provision of this specification during operating condition or after storage or shipment condition specified below. Operation at 10% beyond the specified range will not cause physical damage to the unit.

### 6.1 Temperature and Humidity

#### 6.1.1 Operating Conditions

The display module operates error free, when operated under the following conditions;

|                      |               |
|----------------------|---------------|
| Temperature          | 0 °C to 50 °C |
| Relative Humidity    | 8% to 95%     |
| Wet Bulb Temperature | 39.0 °C       |

### 6.1.2 Shipping Conditions

The display module operates error free, after the following conditions;

|                      |                 |
|----------------------|-----------------|
| Temperature          | -20 °C to 60 °C |
| Relative Humidity    | 8% to 95%       |
| Wet Bulb Temperature | 39.0 °C         |

### 6.2 Atmospheric Pressure

The display assembly is capable of being operated without affecting its operations over the pressure range as following specified;

|                  | Pressure | Note                |
|------------------|----------|---------------------|
| Maximum Pressure | 1040hPa  | 0m = sea level      |
| Minimum Pressure | 674hPa   | 3048m = 10.000 feet |

Note : Non-operation attitude limit of this display module = 30,000 feet. = 9145 m.

### 6.3 Thermal Shock

The display module will not sustain damage after being subjected to 100 cycles of rapid temperature change. A cycle of rapid temperature change consists of varying the temperature from -20°C to 60°C, and back again.

|                            |                                     |
|----------------------------|-------------------------------------|
| <b>Thermal shock cycle</b> | -20 °C for 30min<br>60 °C for 30min |
|----------------------------|-------------------------------------|

Power is not applied during the test. After temperature cycling, the unit is placed in normal room ambient for at least 4 hours before powering on.

## 7.0 Reliability

This display module and the packaging of that will comply following standards.

### 7.1 Failure Criteria

The display assembly will be considered as failing unit when it no longer meets any of the requirements stated in this specification. Only as for maximum white luminance, following criteria is applicable.

**Note : Maximum white Luminance shall be 125 cd/m<sup>2</sup> or more.**

### 7.2 Failure Rate

The average failure rate of the display module (from first power-on cycle till 1,000 hours later) will not exceed 1.0%. The average failure rate of the display module from 1,000 hours until 16,000 hours will not exceed 0.7% per 1000 hours.

### 7.2.1 Usage

The assumed usage for the above criteria is:

- 220 power-on hours per month
- 500 power on/off cycles per month
- Maximum brightness setting
- Operation to be within office environment (25°C typical)

### 7.2.2 Component De-rating

All the components used in this device will be checked the load condition to meet the failure rate criteria.

### 7.3 CCFL Life

The assumed CCFL Life will be longer than 50,000 hours, typical value is 50,000 hours under stable condition at 25 ± 5°C;

Standard current at 6.0 ± 0.5mA.

Definition of life: brightness becomes 50% or less than the minimum luminance value of CCFL.

### 7.4 ON/OFF Cycle

The display module will be capable of being operated over the following ON/OFF Cycles.

| ON/OFF              | Value  | Cycles                         |
|---------------------|--------|--------------------------------|
| +Vin and CCFL power | 30,000 | 10 seconds on / 10 seconds off |

## 8.0 Safety

### 8.1 Sharp Edge Requirements

There will be no sharp edges or comers on the display assembly that could cause injury.

### 8.2 Materials

#### 8.2.1 Toxicity

There will be no carcinogenic materials used anywhere in the display module. If toxic materials are used, they will be reviewed and approved by the responsible AUO Toxicologist.

#### 8.2.2 Flammability

All components including electrical components that do not meet the flammability grade UL94-V1 in the module will complete the flammability rating exception approval process. The printed circuit board will be made from material rated 94-V1 or better. The actual UL flammability rating will be printed on the printed circuit board.

### 8.3 Capacitors

If any polarized capacitors are used in the display assembly, provisions will be made to keep them from being inserted backwards.

## 9.0 Other requirements

### 9.1 National Test Lab Requirement

The display module will satisfy all requirements for compliance to

**UL 1950, First Edition**

**CSA C22.2 No.950-M89**

**EEC 950**

**EN 60 950**

U.S.A. Information Technology Equipment

Canada, Information Technology Equipment

International, Information Technology Equipment

International, Information Processing Equipment  
(European Norm for IEC950)

### 9.2 Label

#### 9.2.1 Product label

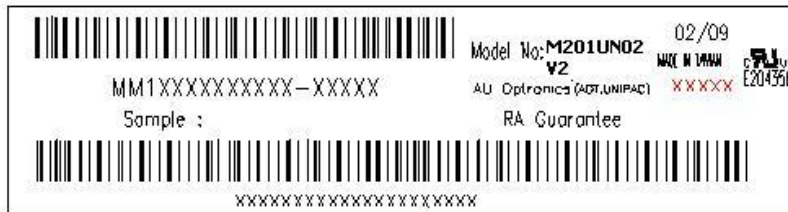

## 10.0 Mechanical Characteristics



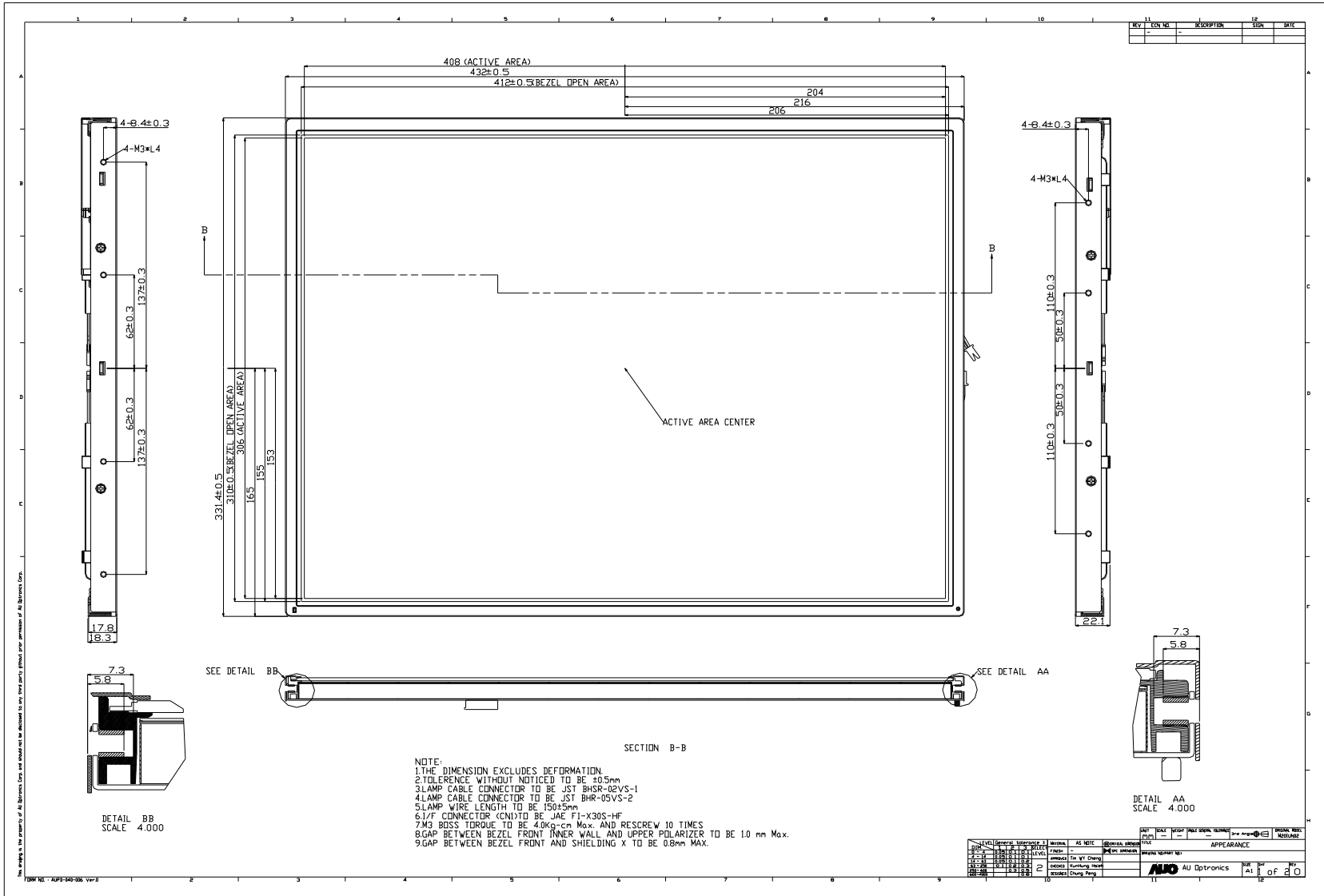

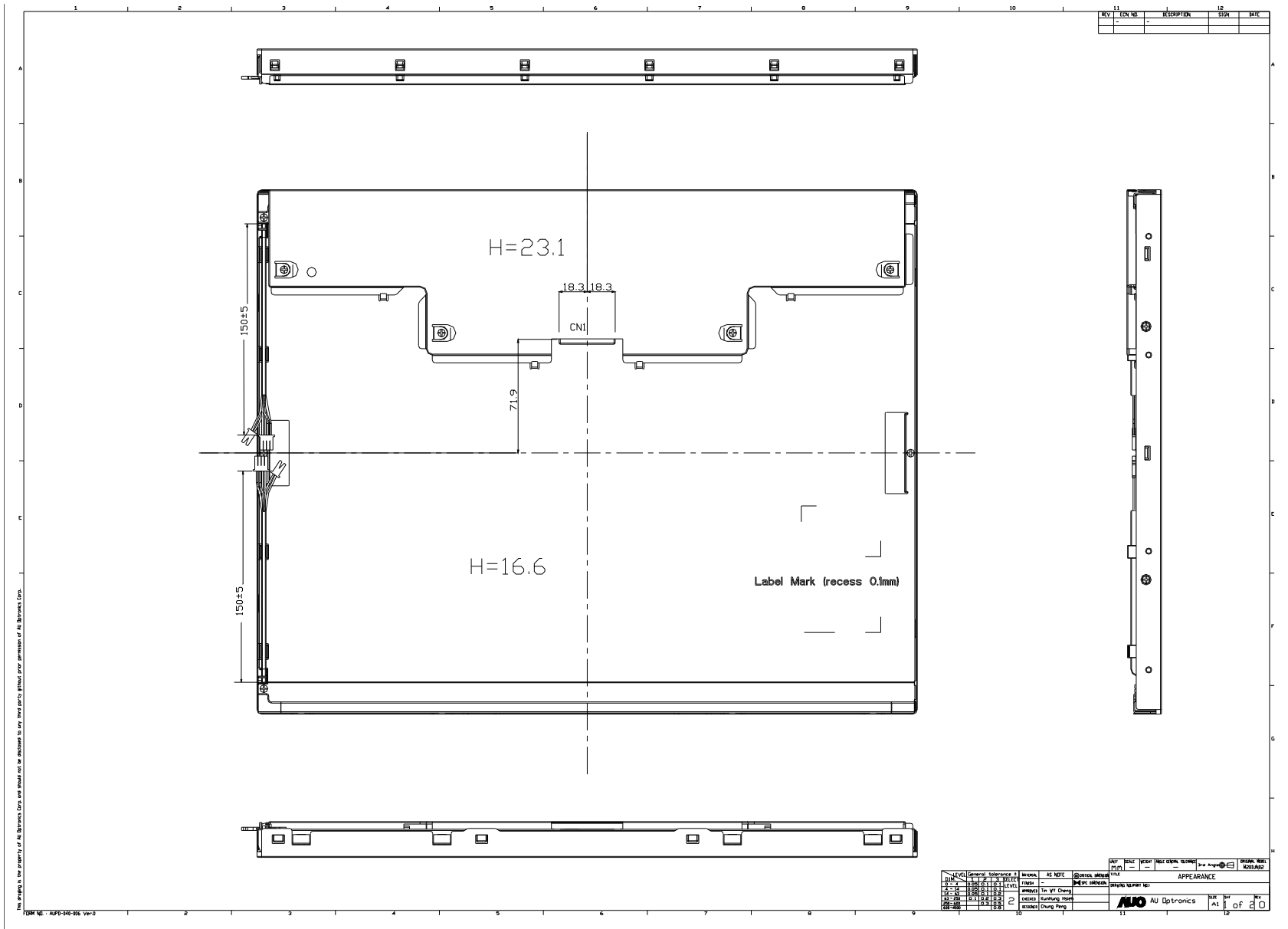

(C) Copyright AU Optronics, Inc.

Dec, 2003 All Rights Reserved.

No Reproduction and Redistribution Allowed.

M201UN02 v.3 Ver1.0

26/26